

## ZF 500-1 IV

14° V-drive, direct mount marine transmission.

### Description

- Fully works tested, reliable and simple to install .
- Design, manufacture and quality control standards comply with ISO 9001 .
- Compatible with all types of engines and propulsion systems, including waterjets and surface- piercing propellers, as applicable .
- Suitable for high performance applications in luxury motoryachts, sport fishers, express cruisers etc .
- Reverse reduction marine transmission with hydraulically actuated multi-disc clutches .

### Features

- Lightweight and robust aluminum alloy casing (sea water resistant) .
- Case hardened and precisely ground gear teeth for long life and smooth running .
- Output shaft thrust bearing designed to take maximum propeller thrust astern and ahead .
- Smooth and reliable hydraulic shifting with control lever for attachment of push-pull cable .
- Suitable for twin engine installations (same ratio and torque capacity in ahead or astern mode) .
- Replaceable oil filter cartridge .
- Compact, space saving design; 14° down-angle and integral SAE 1 bell housing .
- "SUPERSHIFT" clutch control .

### Options

- Engine-matched torsional coupling .
- Propeller shaft flange and coupling bolt sets .
- Classification by all major Classification Societies on request .
- Oil cooler complete with fittings and flexible oil hoses .
- Mounting brackets .
- Electric clutch control (12 or 24 VDC) .
- PTOs (live or clutchable - retrofittable) .
- Mechanical or Electrical Trolling Valve for slow-speed drive .
- Supershift (with Autotroll and Easidock) .

# ZF 500-1 IV

## Ratings

### Pleasure Duty

RATIOS	MAX. TORQUE		POWER/RPM		INPUT POWER CAPACITY						MAX. RPM
	Nm	ftlb	kW	hp	2100 rpm		2300 rpm		2450 rpm		
1.216, 1.485, 1.767, 1.964	3737	2756	0.3913	0.5248	822	1102	900	1207	959	1286	3000
2.200	3644	2688	0.3816	0.5117	801	1075	878	1177	935	1254	3000
2.478	3360	2478	0.3518	0.4718	739	991	809	1085	862	1156	3000
3.000	2786	2055	0.2917	0.3912	613	822	671	900	715	958	3000

\* Special Order Ratio.

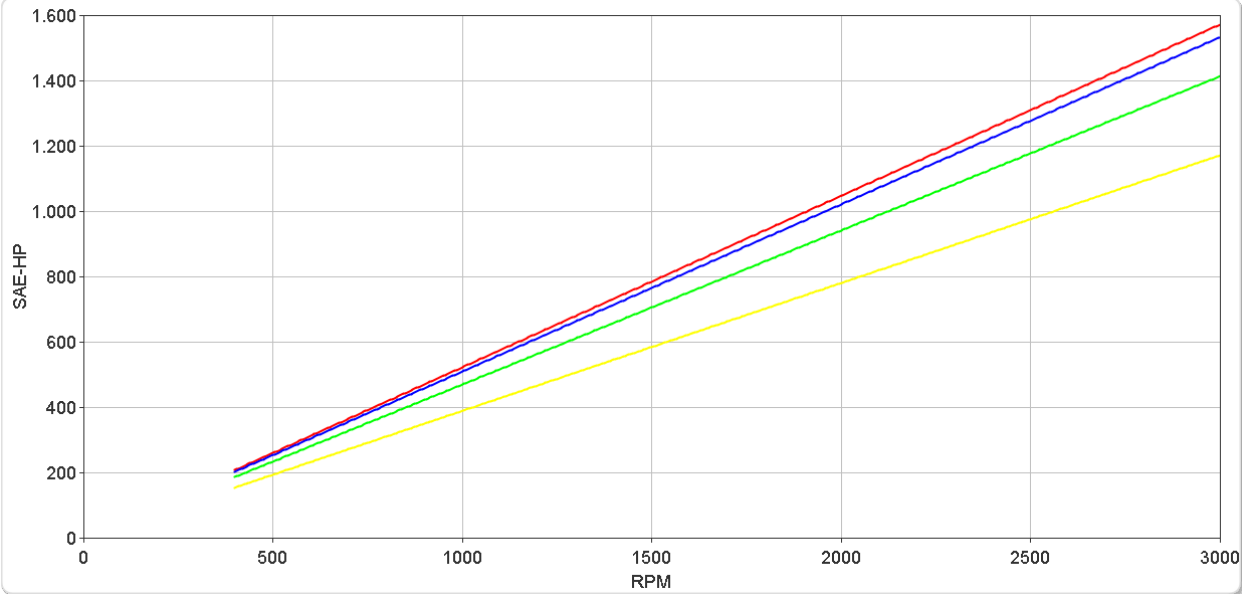
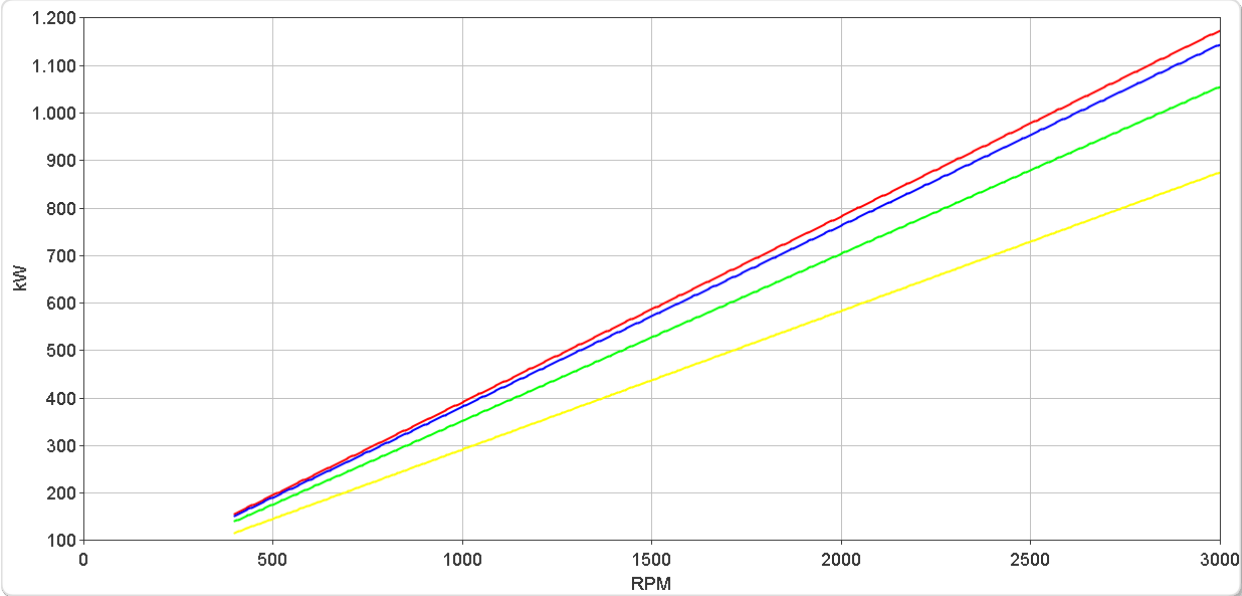

# ZF 500-1 IV

## Ratings

### Light Duty

	RATIOS	MAX. TORQUE		POWER/RPM		INPUT POWER CAPACITY						MAX. RPM
		Nm	ftlb	kW	hp	2100 rpm		2300 rpm		2450 rpm		
						kW	hp	kW	hp	kW	hp	
■	1.216, 1.485, 1.767, 1.964	3406	2512	0.3566	0.4783	749	1004	820	1100	874	1172	3000
■	2.200	3096	2283	0.3242	0.4347	681	913	746	1000	794	1065	3000
■	2.478	2941	2169	0.3080	0.4130	647	867	708	950	754	1012	3000
■	3.000	2632	1941	0.2756	0.3696	579	776	634	850	675	905	3000

\* Special Order Ratio.

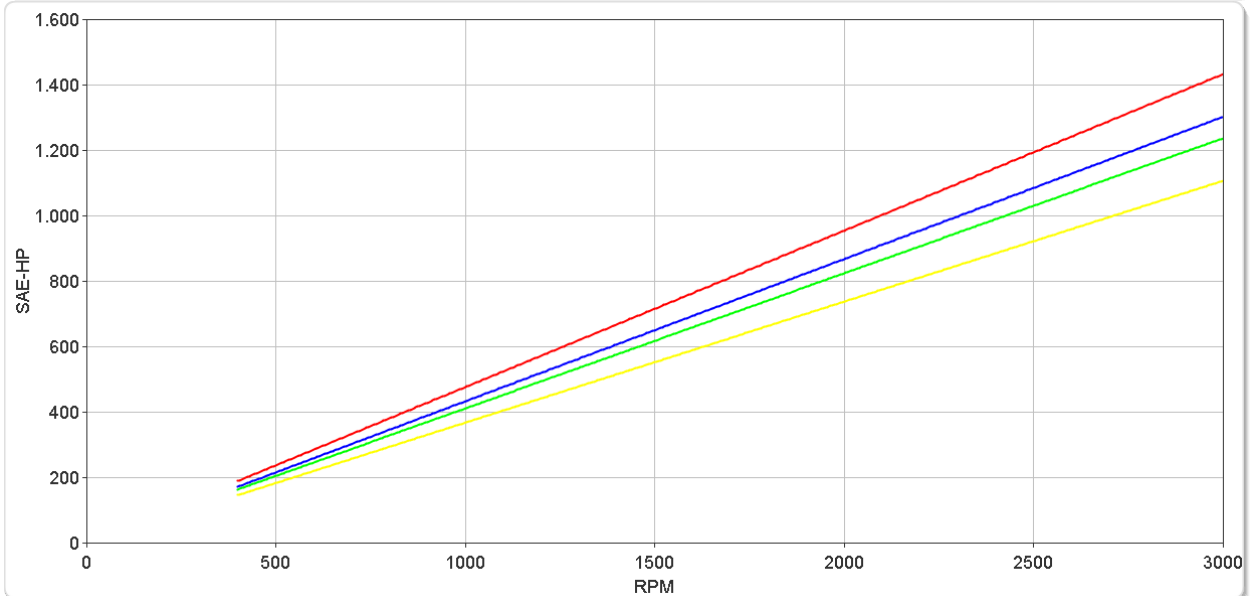
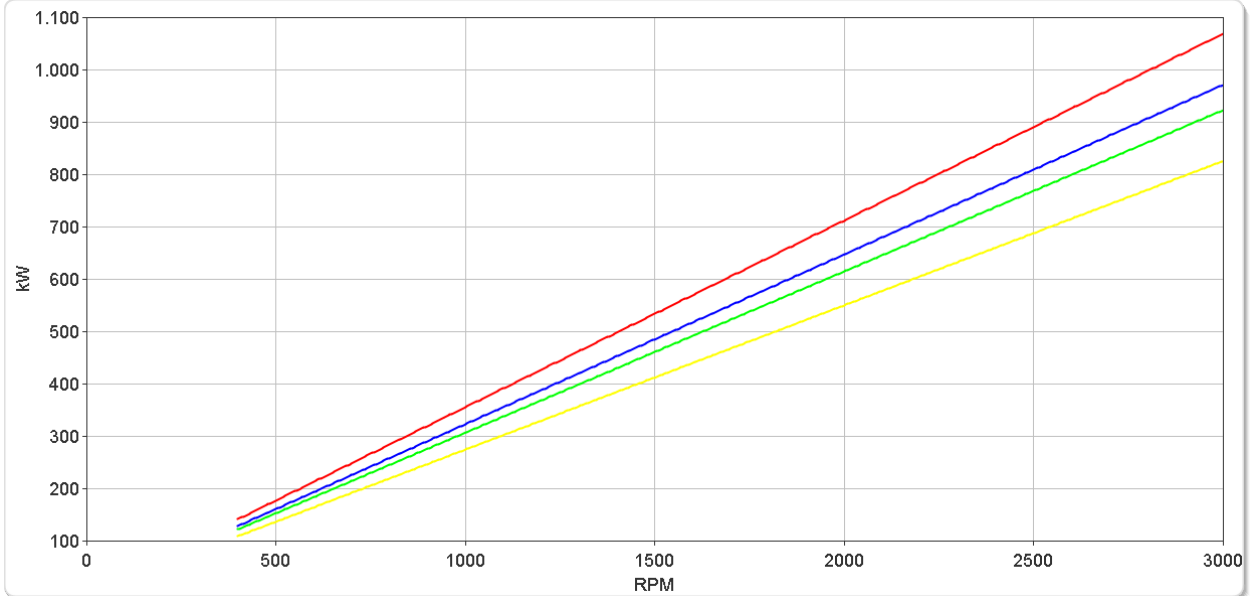

# ZF 500-1 IV

## Ratings

### Medium Duty

RATIOS	MAX. TORQUE		POWER/RPM		INPUT POWER CAPACITY						MAX. RPM
	Nm	ftlb	kW	hp	1800 rpm		2100 rpm		2250 rpm		
					kW	hp	kW	hp	kW	hp	
1.216, 1.485, 1.767, 1.964	2458	1813	0.2574	0.3452	463	621	541	725	579	777	3000
2.200	2374	1751	0.2486	0.3334	447	600	522	700	559	750	3000
2.478	2176	1605	0.2279	0.3056	410	550	478	642	513	688	3000
3.000	1978	1459	0.2071	0.2778	373	500	435	583	466	625	3000

\* Special Order Ratio.

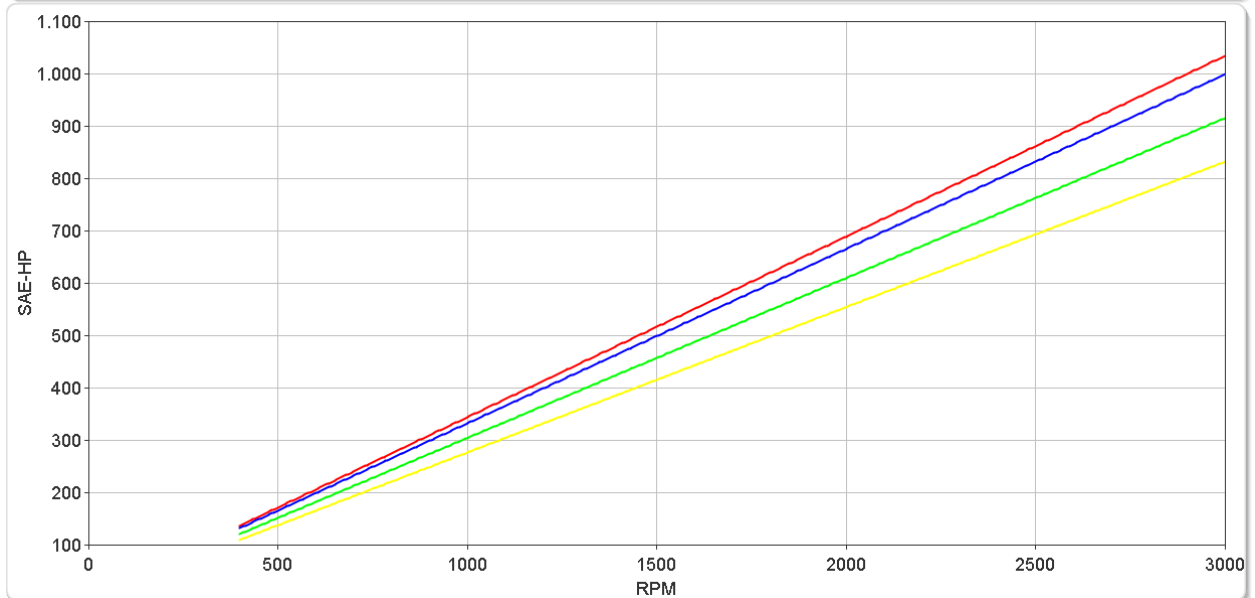
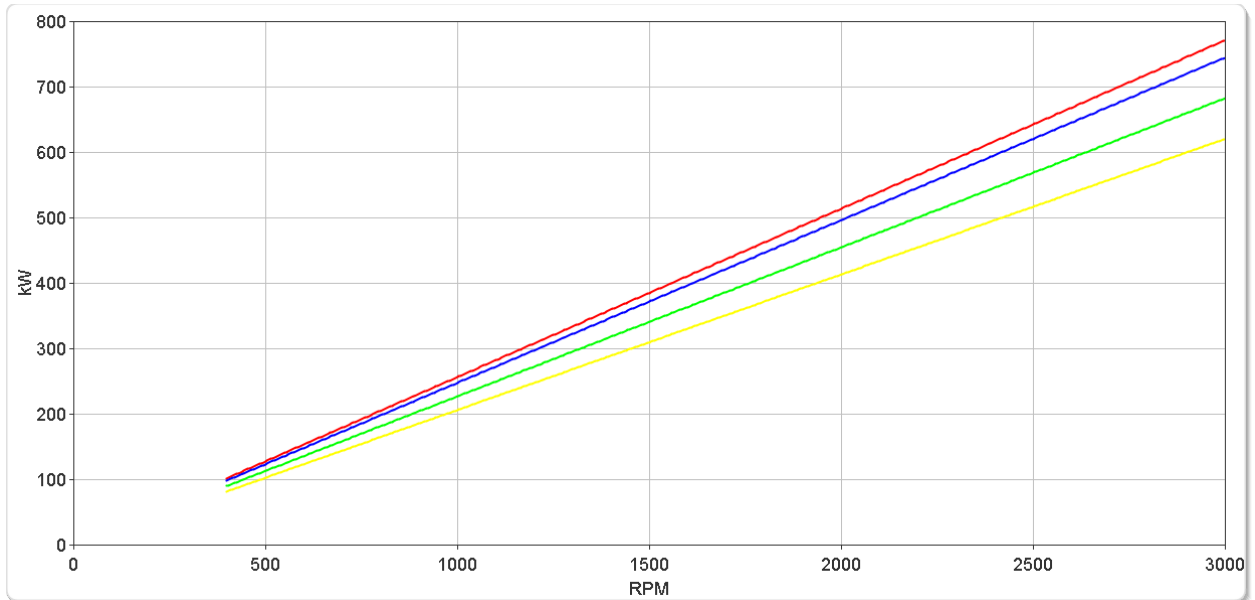

# ZF 500-1 IV

## Dimensions

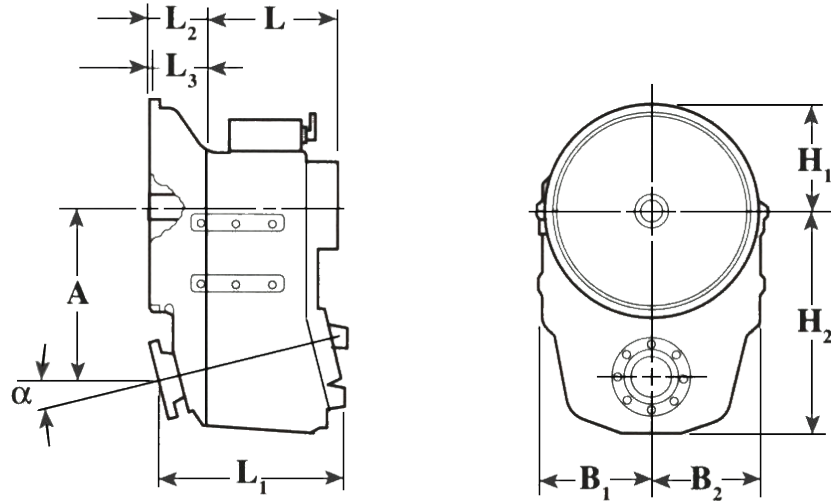

mm (inches)										
Angle	A	B <sub>1</sub>	B <sub>2</sub>	H <sub>1</sub>	H <sub>2</sub>	L	L <sub>1</sub>	L <sub>2</sub>	L <sub>3</sub>	Bell Hsg.
14.0	392 (15.4)	292 (11.5)	220 (8.66)	145 (5.70)	627 (24.7)	358 (14.1)	372 (14.6)	280 (11.0)	-	
Weight kg (lb)						Oil Capacity Litre (US qt)				
230 ( 507)						9.00 (9.50)				

### SAE Bell Housing Dimensions

SAE No.	A		B		C		Bolt Holes No.	Diameter	
	mm	in	mm	in	mm	in		mm	in
1	511.18	20.125	530.23	20.875	552.45	21.75	12	11.91	15/32

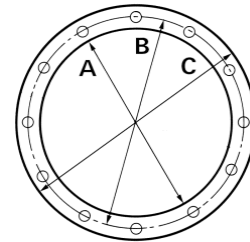

### Output Coupling Dimensions

A		B		C		D		Bolt Holes No.	Diameter (E)	
mm	in	mm	in	mm	in	mm	in		mm	in
205	8.07	170	6.69	140	5.51	20.0	0.79	10	18.3	0.72

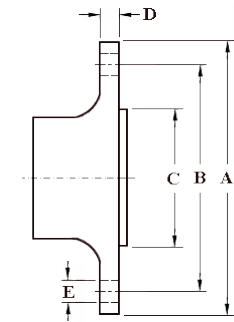

## Duty Definitions

**PLEASURE DUTY DEFINITION** Highly intermittent operation with very large variations in engine speed and power

Average engine operating 500 hours/year  
hours limit: 300 hours/year for mechanical gearboxes

Typical hull forms: Planing.

Typical applications: Private, non-commercial, non-charter sport/leisure activities.

**LIGHT DUTY DEFINITION** Intermittent operation with large variations in engine speed and power

Average engine operating 2500 hours/year  
hours limit: (for hydraulic gearboxes smaller than the ZF 650 series, 2000 hours/year).

Typical hull forms: Planing and semi-displacement.

Typical applications: Private and charter, sport/leisure activities, naval and police activities.

**MEDIUM DUTY DEFINITION** Intermittent operation with some variations in engine speed and power

Average engine operating 4000 hours/year.  
hours limit: 3500 hours/year for gearboxes smaller than ZF 2000 series and workboat ZF W2700 series.

Typical hull forms: Semi-displacement and displacement

Typical applications: Charter and commercial craft (example: crew boats and fast ferries), and naval and police activities.

## Duty Ratings

Ratings apply to marine diesel engines at the indicated speeds. At other engine speeds, the respective power capacity (kW) of the transmission can be obtained by multiplying the Power/Speed ratio by the speed.

Approximate conversion factors:

1 kW = 1.36 metric hp

1 kW = 1.34 U.S. hp (SAE)

1 U.S. hp = 1.014 metric hp

1 Nm = 0.74 lb.ft.

Ratings apply to right hand turning engines, i.e. engines having counterclockwise rotating flywheels when viewing the flywheel end of the engine.

These ratings allow full power through forward and reverse gear trains, unless otherwise stated.

Contact your nearest ZF Sales and Service office for ratings applicable to gas turbines, gasoline (petrol) engines, as well as left hand turning engines, and marine transmissions for large horsepower capacity engines.

Ratings apply to marine transmissions currently in production or in development and are subject to change without prior notice.

**NOTE: THE MAXIMUM RATED INPUT POWER MUST NOT BE EXCEEDED (SEE RESPECTIVE RATINGS IN THE TECHNICAL DATA SHEETS)**

## Safe Operating Notice

The safe operation of ZF products depends upon adherence to technical data presented in our brochures. Safe operation also depends upon proper installation, operation and routine maintenance and inspection under prevailing conditions and recommendations set forth by ZF. Damage to transmission caused by repeated or continuous emergency manoeuvres or abnormal operation is not covered under warranty. It is the responsibility of users and not ZF to provide and install guards and safety devices, which may be required by recognized safety standards of the respective country (e.g. for U.S.A. the Occupational Safety Act of 1970 and its subsequent provisions).

## Monitoring Notice

The safe operation of ZF products depends upon adherence to ZF monitoring recommendations presented in our operating manuals, etc. It is the responsibility of users and not ZF to provide and install monitoring devices and safety interlock systems as may be deemed prudent by ZF. Consult ZF for details and recommendations.

## Torsional Responsibility and Torsional Couplings

The responsibility for ensuring torsional compatibility rests with the assembler of the drive and driven equipment. ZF can accept no liability for gearbox noise caused by vibrations or for damage to the gearbox, the flexible coupling or to other parts of the drive unit caused by this kind of vibration. Contact ZF for further information and assistance. ZF recommends the use of a torsional limit stop for single engine powered boats, wherein loss of propulsion power can result in loss of control. It is the buyer's responsibility to specify this option, which can result in additional cost and a possible increase in installation length.

ZF can accept no liability for personal injury, loss of life, or damage or loss of property due to the failure of the buyer to specify a torsional limit stop. ZF selects torsional couplings on the basis of nominal input torque ratings and commonly accepted rated engine governed speeds. Consult ZF for details concerning speed limits of standard offering torsional couplings, which can be less than the transmission limit. Special torsional couplings may be required for Survey Society Ice Classification requirements.